

FIXED PRESSURE DIVERTER VALVE - 250 Bar

360034250

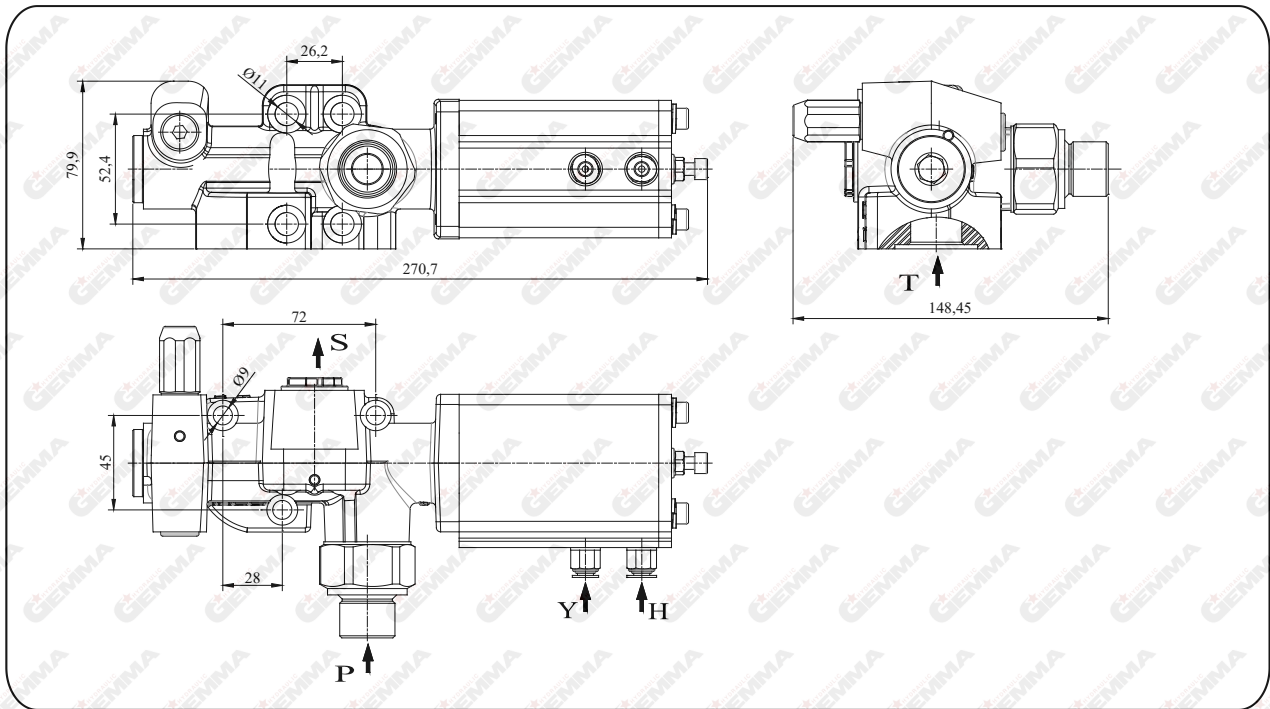
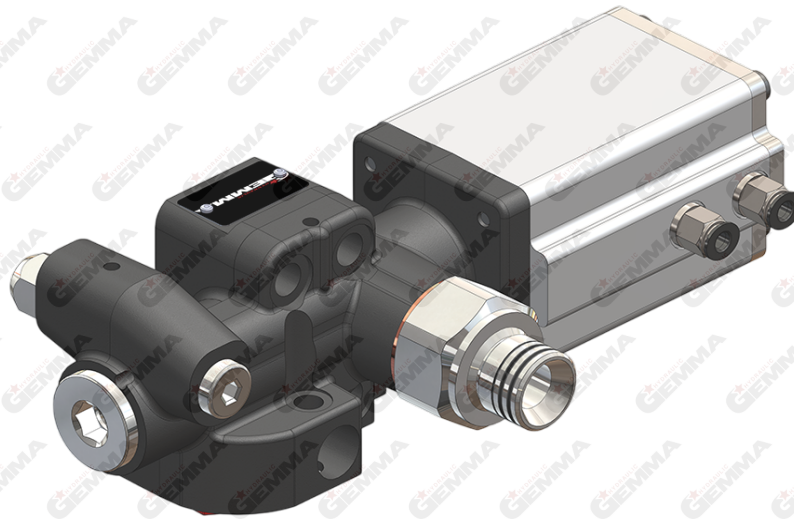

VALVES
VENTİLLER

HYDRAULIC EQUIPMENT
HİDROLİK EKİPMANLAR

SPECIFICATIONS	
Cylinder connection	R 3/4"
Pump connection	R 3/4"
Tank connection	R 3/4"
Cylinder lowering	R 1/8"
Cylinder tipping	R 1/8"
Max.working pressure	250 bar
Max. Flow	150 L/dak
Oil Temperature Range	-20 & 80 °C
Weight	4 kg

